



U1512EA Series

High Speed Hands Free Dryer

Revision 08/16

JOB #:

ITEM #:

QUANTITY:

MOUNTING	HANDING	TYPE	SIZE	OTHER

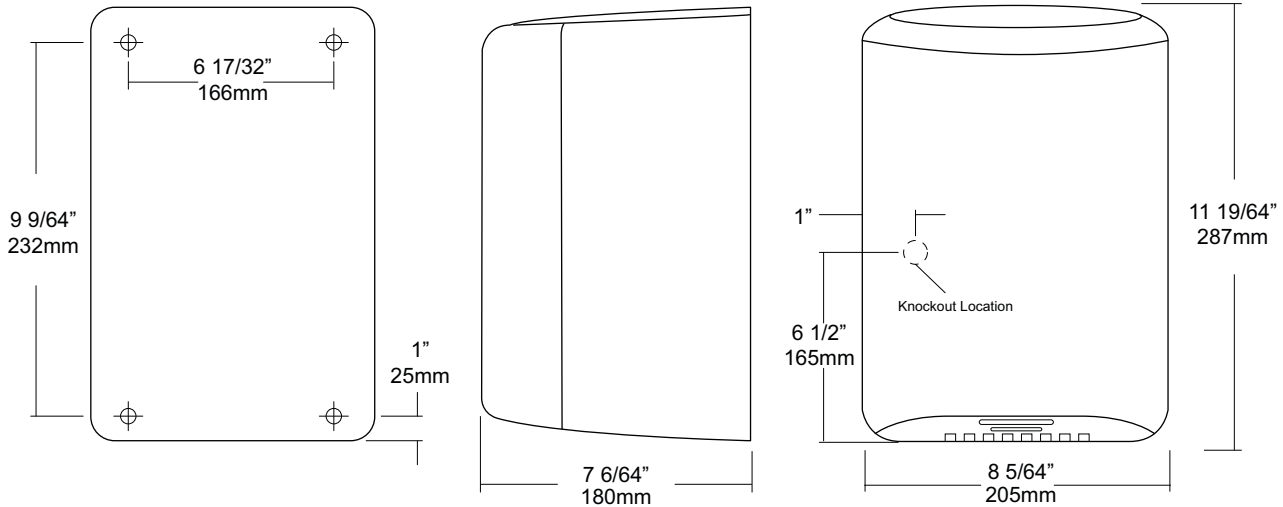

SPECIFICATIONS

Motor: Brush type, dual ball bearings, 12000 – 18000 RPM (adjustable), 15/16 HP thermally protected against overheating and is auto resetting. Available in 120 or 230V with 50 / 60 HZ

Heater Element: 450 – 900 watt (adjustable) Air output temperature is 113 degrees F at nozzle with an ambient temperature of 68 degrees F. Dryer shall deliver 51-68 CFM

Drying: 15 second drying time in optimum conditions. Timing protection feature of 60 seconds will automatically turn off and not restart until the sensor reset's itself.

Sensor: Hands free operation with adjustable sensor range 2" – 13". Standard range is 7".

Cover: High gloss white painted steel cover secured to base with theft resistant fasteners.

Overall Size: 8 5/64"W x 11 19/64"H x 7 6/64"D
(205mm x 287mm x 180mm)

U1512EA-SF: Same as U1512EA with satin finish, stainless steel cover.

Unit	Volts	Amps	Cycles
U1512EA-120V	110-120	14	50/60
U1512EA-230V	208-230	7	50/60

INSTALLATION

Coordinate installation with architect and contractor to avoid interference with pipes, vents, etc in wall. Insure the service for the hand dryer is correct for the dryer being installed. The dryer must be installed by a licensed electrical contractor to honor warranty. Place template on wall surface and transfer all mounting point locations. Check all codes for proper mounting heights for each application. All mounting heights must be based on a finished floor to eye sensor location dimension. Secure base to wall surface with proper anchors. (Anchoring devices not supplied) Properly connect power supply to dryer and test operation before securing cover. After dryer checks good secure cover with theft resistant fasteners supplied. Test dryer again for proper operation. Recommend one dryer for every two basins.

NOTES

Formerly Model #: U1512EA